

AVANT[®]

525 LPG

Operator's Manual 2012-



TABLE OF CONTENTS

Table of contents	2	Coupling the attachments	24
Introduction, warranty	3	Hydraulic attachment coupling plate	24
Safety instructions	4	Coupling the hydraulic hoses of the attachment	25
Description of the loader	7	Service and maintenance instructions	26
Main parts of the loader	8	Safety instructions for maintenance	26
Signs and decals	9	Releasing the pressure of hydraulic system...26	
Technical specification	10	Installing of service support and frame lock..27	
Load diagram	11	Daily inspections	27
Transporting instructions and tie down points .	12	Maintenance schedule	27
Operating instructions	13	Cleaning of the machine	28
Controls	14	Greasing of the machine	28
Control of loader boom, auxiliary hydraulics and other functions	15	Battery check	28
Attachment control switch pack	15	Hydraulic oil level.....28	
Dashboard	16	Hydraulic oil filter change	28
Controls in the footwell.....16		Hydraulic oil change.....28	
Suspension seat	17	Check and tightening of bolts, nuts etc.....28	
Telescopic boom	17	Check of hydraulic pressure	28
Battery disconnect switch.....17		Adjustment of hydraulic pressure	29
Boom self levelling	17	Adjust and change of slide pads on telescopic boom	29
Boom floating.....17		Function and calibration of load sensor	30
Joystick.....18		Change of LPG system pre filter.....30	
Engine block heater	18	Service, engine	30
Trailer coupling	18	Fuse box.....30	
Extra counterweights.....18		Jump start and auxiliary power	30
Drive release valve.....18		Safety instructions when handling the battery..30	
Anti slip valve	18	Greasing points	31
Work light kit	18	LPG system, parts.....31	
Snow chains	18	Filters	32
Tilt adapter	19	Light bulbs.....32	
Extra auxiliary hydraulics outlets, front and rear.....19		Storage of the machine	32
Starting the engine	20	Troubleshooting	33
Stopping the engine	20	Service history	34
Drive control	21	EC Declaration of Conformity	35
Driving the machine.....22			
Loader control	22		
Using the auxiliary hydraulics.....22			
Cabs	23		
Requirements for attachments.....24			

Introduction

AVANT TECNO OY wants to thank you for purchasing this AVANT loader. It is the result of Avant's long experience in design and manufacturing of compact loaders.

We ask you that you read and understand the contents of this manual completely before operating the loader. This will improve your operating and maintenance efficiency, help avoid breakdowns and damage and extend your machine's life.

Contact your local AVANT dealer for any questions, service, spare parts or about any problems that may occur with the operation of your machine.

Keep this Operators Manual with the machine at all times. If this Manual gets lost, ask for a new copy from your Avant dealer. Remember also to give this Manual to the new owner when the machine changes ownership.

Intended use

AVANT 525LPG is an articulated compact loader, designed and manufactured for both professional and private use. The loader can be equipped with attachments offered by Avant Tecno Oy, which enables doing of several different jobs. Because of this multi purpose nature of the machine and the various attachments and tasks, read always not only this Manual but also the Operators Manual of the attachment, and follow all instructions. Every person who has to do with this machine must follow work safety regulations, all other generally accepted rules related to work health and safety, and all road traffic regulations.

Remember that safety consists of several factors. The loader, equipped with an attachment is very powerful and can cause serious personal injuries or property damages if it is operated in a wrong or careless way. Do not operate an attachment unless you have familiarised yourself with the use of it and the eventual dangers related to it.

These operating instructions are intended to help to:

- operate this machine safely and efficiently
- observe and prevent situations that may cause a risk or danger
- keep the machine in good condition and its life span as long as possible

This loader has been designed to require as little maintenance as possible. The operator can perform the most common maintenance operations. There are however more demanding service operations that can be done by professional service personnel only. It is allowed to perform service operations only when wearing appropriate protective equipment. Original spare parts must be used. Familiarise yourself with the service and maintenance instructions in this Manual.

Contact your local AVANT dealer, if you are uncertain of anything concerning the operation and maintenance of this loader, or for any questions, service or spare parts.

AVANT 525LPG WARRANTY

This warranty specifically applies to the AVANT 525LPG loader only and not to any attachments used with this product.

Any repairs or modifications performed without the prior authorisation of Avant Tecno Oy will cancel this warranty.

During the first year of operation or first 750 hours (whichever is the soonest) Avant Tecno Oy warrants to replace any part or repair any defect which may occur, subject to the terms detailed below:

- 1) The product has received regular maintenance in accordance with schedules given by the manufacturer.
- 2) Any damage caused by operation in a negligent manner or exceeding the approved specifications detailed in this manual is excluded.
- 3) Avant Tecno Oy accepts no responsibility for interruption to working or any other consequential losses resulting from any failure of the product.
- 4) Only Avant Tecno Oy approved replacement or original quality parts shall be used during routine maintenance.
- 5) Any damage caused by the use of incorrect fuel, lubricants, cooling liquid or cleaning solvents is excluded.
- 6) The Avant Warranty excludes any consumable parts (e.g. tyres, batteries, filters, belts etc.) except where it can be clearly shown that these parts were defective on original supply.
- 7) Any damage caused resulting from the use of attachments not approved for use with this product is excluded.
- 8) In the event a fault occurs which is attributable to manufacturing or assembly defect you should arrange to return your AVANT to your authorised dealer for repair. Travel and freight costs are excluded.

Safety first

Following symbols are used throughout this Manual to point out important things related to safety:



This safety symbol indicates important safety instructions in this Manual. It warns of an immediate hazardous situation that can cause serious personal injuries or property damages. Read carefully the warning text next to this symbol and make sure that all other operators are aware of the warnings as well. It is a question of safety of persons.



This attention symbol indicates important instructions concerning correct use and maintenance of this machine. If these instructions are not followed, the consequence can be breakdown of the machine or property damage.



An incorrect or careless operation of the loader may be the origin of a serious accident. Before putting the machine into operation, familiarise yourself with the use of the machine and read and understand this Operators Manual as well as the safety instructions.

Understand the limitations of speed, braking, steering and stability as well as loading capacity of the machine before starting operation. Make sure that every one who operates or works with this equipment is familiar with these safety precautions.

If you have no previous experience of the machine, make sure to do all testing at a safe and open place with no persons in the area of operation.



Read this Operators Manual, and also the Operators Manual of the attachment(s) and other safety instructions before starting operation.

General instructions

1. Start the operation slowly and carefully. Practice driving of the machine at a safe and open place before connecting any attachment, follow the instructions in this Manual.
2. Operate the control levers with ease and without hesitation. Avoid abrupt movements when handling the load, in order to prevent the load from falling and to keep the machine stable.
3. Keep away from the danger zone of the lifted boom and don't let anyone go there.
4. Keep your hands, feet and clothing away from all moving parts, hydraulic components and hot surfaces.
5. Remember the correct working position. When

driving be comfortably seated in the driver's seat, keep your feet in their proper place in the footwell and at least one hand on the steering wheel.

6. Make sure that there is enough open space around the machine for safe driving.
7. Do not transport the load with the boom lifted. Always carry bucket or attachment as low as possible, and put the load down whenever you leave the machine.
8. Before leaving driver's seat:
 - Lower the loader boom and place attachment flat on ground
 - Engage the parking brake – make sure that it locks into locking position
 - Stop the engine, remove the ignition key
9. It is not allowed to transport persons with this machine. Do not transport or lift persons in the bucket or in any other attachment. Lifting of persons is only allowed with the attachment designed for this purpose: Avant Leguan 50, following the instructions in the Operators Manual of Leguan 50.
10. Do not exceed rated operating capacity. Familiarise yourself with and follow the load diagrams in this Manual.
11. When turning with the machine, remember that the driver's seat extends beyond the turning radius of the wheels (collision risk).
12. Do not operate the loader in an explosive environment or in a place where dust or/and gases can create a fire or explosion hazard.
13. Keep the engine area clean of flammable materials.
14. Read the transportation instructions on page 12.
15. Switch off the battery disconnect switch during storage.
16. Follow all inspection, service and maintenance instructions. If you notice any faults or damages on the machine, these must be repaired before starting operation.
17. Before any maintenance or repair operation always stop the engine, lower the boom down and release pressure from hydraulic system. Read safety instructions for maintenance on page 26.
18. Do not let any person operate this loader who has not read safety instructions and is not familiar with the safe and correct use of this loader.

Operation on gradients

19. Load, unload, and turn on flat level ground only. Drive slowly on uneven terrains. Do not drive on too steep a gradient - watch out for ditches, manholes and steep gradients.
20. Do not park the machine on a surface with a gradient. Should this be necessary, engage the parking brake and preferably turn the machine sideways and put down the load. If needed, use chocks behind the wheels.



Avant 525LPG is not suited for road traffic use.

Handling of heavy loads and load sensor

The loader is equipped with a load sensor system. It gives an audible warning signal and at the same time an indicator lights in the dashboard when there is a risk that the machine tips over its front axle. When the system gives a warning signal the load that is being lifted is too heavy in relation with the lift capacity of the loader. In this case one has to either put more counterweights on the loader or relieve the load that is being lifted.



When the load sensor starts to warn, there is a risk that the machine tips over its front axle. In this case stop lifting of the boom, retract the telescopic boom and lower down the boom slowly. When the load sensor is warning do not steer the machine before the boom is lowered down close to ground level. Lift the boom only when the loader chassis is straight. Keep the load as close to ground as possible.



Never take a heavy load on the loader from high level – e.g. from truck, shelf etc. – risk of tipping over!

Always put the load down on the ground before leaving the machine. When loading, always keep the loader chassis as straight as possible.

Personal safety and protective equipment

Wear safe clothing and personal protective equipment (PPE). Protect yourself against work hazards like noise, ejecting debris or dust for example.



- Noise level at driver's seat can exceed 85 dB(A). Wear hearing protection when working with the loader.
- It is recommended to wear safety footwear when working with the loader.
- Wear protective gloves when handling hydraulic hoses.
- Follow regulations regarding protective equipment. Wear eye protection and hard hat or other protective equipment as needed.

Read Operators Manual of the attachment for more information about protective equipment needed in the work.

Safety frame (ROPS) and safety canopy (FOPS)



Safety frame (ROPS) protects the operator in case the machine tips over. Always fasten the seat belt in order to stay inside the safety frame protective area. Never take off the safety frame.

When working in conditions where falling objects may be a risk (on building sites etc.), the loader must be equipped with a falling objects protective canopy (FOPS), part no. A48906.

Electric system

Lead acid batteries can produce flammable and explosive gases. Make sure that the ventilation is sufficient and keep arcs, sparks, flames and lighted tobacco away from battery.

Battery acid causes severe burns. In case of acid contact, wash immediately with water for several minutes and get medical attention in case of eye contact.

Read the instructions for jump start on page 30. Never charge a frozen battery.

AVANT 525LPG safety



Make sure that ventilation is sufficient in the working area, also when working with the loader with an LPG engine. The emissions of a vehicle with LPG (Liquefied Petroleum Gas) engine are cleaner than those of a diesel engine, but using the loader in poorly ventilated areas can lead to dangerously high levels of carbon monoxide (CO) and dioxide (CO₂) in the air.



- Liquefied Petroleum Gas is extremely flammable and can, when it mixes with air, create an explosive mixture which ignites very easily. Handle the LPG equipment with care and stop the use immediately if you think that it may be damaged. Contact authorized service to sort out the problem.

- Remember that LPG is heavier than air. Make sure to ventilate well.
- Always close the gas bottle valve when the loader is not in operation.
- Stop the engine and switch off main current with the battery disconnect switch when changing the gas bottle.
- Service the LPG system regularly and replace damaged or worn out components immediately. Do not make changes to the LPG system. Contact authorized service if necessary.
- Remember that the gas vaporizer can cool down to a very low temperature during operation, which may cause that moisture in the air condensates on the vaporizer. It is not allowed to heat the vaporizer with any external heater.

In case of gas leak

- Stop the engine and switch off main current immediately.
- Close the gas bottle valve and let the engine cool down completely. Ventilate well.
- Find out the location of the gas leak by wetting down the parts with soap-water solution. Replace faulty components. Contact authorized Avant service if necessary.

General information about LPG and handling of gas bottle

Liquefied gas that is meant for internal combustion engines in vehicle use (LPG, Liquefied Petroleum Gas, also called autogas) is either purely propane or a mixture of propane and butane, without any special additives. This loader is designed to be equipped with an 11 kg LPG bottle destined for vehicle use.



Please note that gas bottles that are intended for heating or cooking cannot be used on this loader. A normal cooking/barbecue gas bottle is different, not only regarding the gas valve but has also different internal piping and function. Gas bottles that are made for vehicle use have a special marking on them.

Do not use natural gas or any other gas that contains methane (biogas EPG / CBG or CNG). In addition to the differences in composition between the gases, the working pressures and the gas systems themselves can be very different. This loader is intended to be used only with a gas bottle that contains liquefied propane/butane for vehicle use. Using of other gases can cause a dangerous situation.

We recommend to use a stainless steel gas bottle. Do not use a steel bottle because of the eventual problems that the internal corrosion of the bottle can cause. There can also be problems when using a composite bottle, because of eventual dirt that comes loose in a composite bottle. In this case the filters in the gas system must be replaced more frequently. In terms of gas vaporization the type of gas bottle doesn't matter, because in vehicle gas systems the gas is vaporized with a separate device (vaporizer).

Filling of the gas bottle requires special equipment and can therefore be done only by a person that has been trained to fill gas bottles. Notice the inspection year that has been marked on the gas bottle. The bottle must be inspected that year in order that its use can be continued.

Close the gas valve carefully, do not overtighten the valve. Do not open the valve more than 2-3 rounds. Gas bottle valve and gas hose normally tighten when turning clockwise.

Store the gas bottle outdoors, in upright position, protected from heat sources and direct sunlight. Install the protective cap on the bottle when it is not in use.

Changing of gas bottle

Change the gas bottle in a well ventilated place, preferably outdoors. Do not change the bottle when the engine is hot, or in the vicinity of heat sources or ignition sources. Never smoke near the gas bottle.

1. Stop the engine by closing the gas valve and letting the engine run until the gas runs out in the piping. Let the engine cool down. Close the gas valve carefully and switch off main current.
2. Detach the gas bottle hose with a 30 mm key and the tool that is on the hose. Opening direction is normal (counterclockwise).



Make sure that dirt or water can not get on the hose during changing.

3. Open the bottle fastening clamp, take off the bottle and replace it with a new gas bottle, with gas valve pointing down.
4. Connect the gas hose to the bottle by tightening it first by hand so that the hose points straight away from the loader. You can keep the hose position correct by using the tool that is on the hose. Make sure to tighten the hose properly, but do not overtighten. If necessary, check tightness by using soap-water liquid and make sure that the bottle fastening clamp is fastened properly.
5. Open the gas valve slowly, about 2-3 rounds, so that the protection valve doesn't switch on because of too fast gas flow when the pipes are filled with gas.

Vehicle gas is usually perfumed, in order that gas smell can be recognised. Because of the perfume the gas smells somewhat also in normal use. If the gas smell is strong, do not start the engine. Find out the reason for the gas leak.

Description of the loader

Identification of the loader

Write down the identification information of your loader in the following fields, it facilitates ordering of spare parts etc.

1. Loader model _____

2. Loader serial no. _____

3. Engine serial no. _____

Serial number of the loader is printed on the type plate (see page 9), which also indicates the loader model.

Location of engine serial number can be found in the Operators Manual of the engine.

Dealer: _____

Contact information: _____

Main parts of the loader

Following picture shows the main parts of the loader:



Hydraulic connectors Multi connector

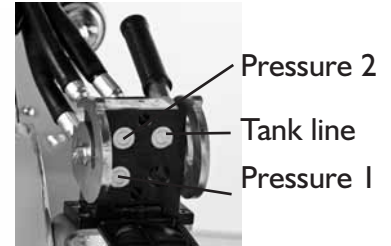

Conventional quick couplers

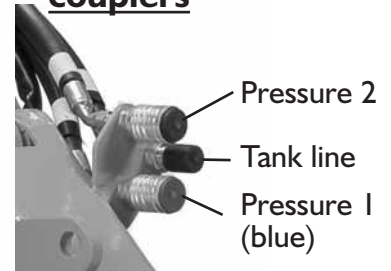

① Front frame

On the front frame are mounted: driver's seat, operating controls, parking brake, hydraulic control valves, hydraulic oil tank, auxiliary hydraulics outlet, front wheels, hydraulic motors and the loader boom with attachment coupling plate.

② Back frame

On the back frame are mounted: engine with accessories, battery, fuel tank, hydraulic pumps, rear wheels, hydraulic motors.

③ Articulation joint

Articulation joint connects the front and back frame. The loader is steered hydraulically by the steering cylinder which is mounted between the front and back frames. Hydraulic hoses and electric wires are conducted through the articulation joint.

④ Loader boom

The attachment coupling plate is mounted on the lower end of the boom. The boom can be telescopic, extending 600 mm hydraulically.

⑤ Attachment coupling plate

Attachments are mounted on the attachment coupling plate. The locking pins on the plate can be operated manually (standard) or hydraulically (option).

⑥ Auxiliary hydraulics outlet

The hydraulic hoses of hydraulically operated attachments are mounted on this outlet. The outlet is equipped with the multi connector quick coupling system and is double acting: it has two pressure lines and one tank line. In addition, as an option, it is also possible to install a single or double acting auxiliary hydraulics outlet in the rear of the machine, or a double acting outlet in the front under the multi connector.

⑦ ROPS safety frame

ROPS frame (Roll-over protective structure) complies with the standard ISO 3471:1994 with Amendment 1:1997 and Technical Corrigendum 1:2000.

⑧ FOPS canopy (option)

FOPS canopy (Falling objects protective structure) mounts on the ROPS. It meets the ISO 3449:1992 (1365 J) criteria.

Signs and decals



Make sure that the following signs and decals clean, undamaged and readable. If any of these decals is missing or is unreadable it should be replaced without delay. Ask for new decals from your local Avant dealer.



①



Sound power level / Sound pressure level at driver's seat

②



Keep out from the danger zone of the machine 2 pcs

③

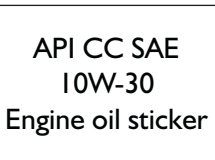

ISO VG-46
Hydraulic oil sticker

④

⑨

⚠️ 📖 Before use read OPERATOR'S MANUAL, especially SAFETY INSTRUCTIONS

CAUTION !!!

- Always perform a daily inspection of the machine before starting operation.
- Operate the control levers and the steering wheel only when sitting in the driver's seat.
- When coupling the attachment, make sure that the locking pins of the attachment coupling plate lock properly down in the holes of the attachment.
- Do not transport the load with the boom lifted. Always carry bucket or attachment as low as possible, and with the telescopic boom completely retracted.

- Drive slowly and do not turn sharply on uneven terrains. Watch out for ditches, manholes and steep gradients.
- Keep hands, feet and clothing away from any moving part.
- Do not transport persons with the machine.
- Before leaving driver's seat:
 - Lower the boom down to the ground
 - Engage the parking brake
 - Stop the engine.

PARKING BRAKE

OFF

ON

A41424

⑤



⑥



⑦



A411456

Risk of crushing, keep hands and feet within the drivers' area

⑧



A411455

Risk of crushing, do not grip the steering wheel from outside the machine or when getting into the driver's seat.

Technical specification

Model	AVANT 525 LPG
Length	2430 mm
Width (23x10.50-12 wheels)	1095 mm
Height (23x10.50-12 wheels)	1980 mm
Ground clearance	200 - 235 mm
Weight, starting from	1070 + 170 kg
Standard wheels	23x10.50-12" tractor
Drive speed (depending on model)	10 km/h
Transmission, drive	hydrostatic
Hydraulic oil tank capacity	38 l
Hydraulic oil quality	ISO VG-46
Hydraulic oil cooler	standard
Auxiliary hydraulics	36 l/min 200 bar
Turning radius inside/outside	995 / 2050 mm
Max. lifting height (with telescopic boom)	2790 mm
Max. lifting capacity (hydr.)	1350 kg
Max. breakout force / 50 cm	1100/1250 kg
Sound power level 2000/14/EC Lp	88 dB (A)
Sound pressure level 2000/14/EC Lw	101 dB (A)
Hand-arm vibration, total	< 2,5 m/s ²
Whole-body vibration, max.	< 0,5 m/s ²

Model	AVANT 525 LPG
Engine make & type	Kubota DF752
Function	4 stroke
Cooling system	water
Number of cylinders	3
Starter	electric
Bore * stroke	68,0 * 68,0 mm
Displacement	740 cm ³
Max. output (ISO Gross)	16 kW (23 hp)
Fuel	autogas (LPG)
Fuel tank capacity	11 kg autogas bottle (stainless steel)
Engine oil type	API CC SAE 10W-30
Engine oil capacity	3,25 l
Charging current max.	40 A
Battery	12V 60Ah

Tipping load, see diagram on page 11.

Tyre	Part no.	Tyre pressure	Machine width
27 x 8.50-15	65019 TR	2,5 bar	990 mm
23x8.50-12	65046 TR 65045 Grass	2,0 bar	1050 mm
23x10.50-12	65048 TR 65047 Grass	2,0 bar	1095 mm
26x12.00-12	64931 TR 64930 Grass	2,0 bar	1289 mm
320/60-12	65028 TR	2,0 bar	1289 mm

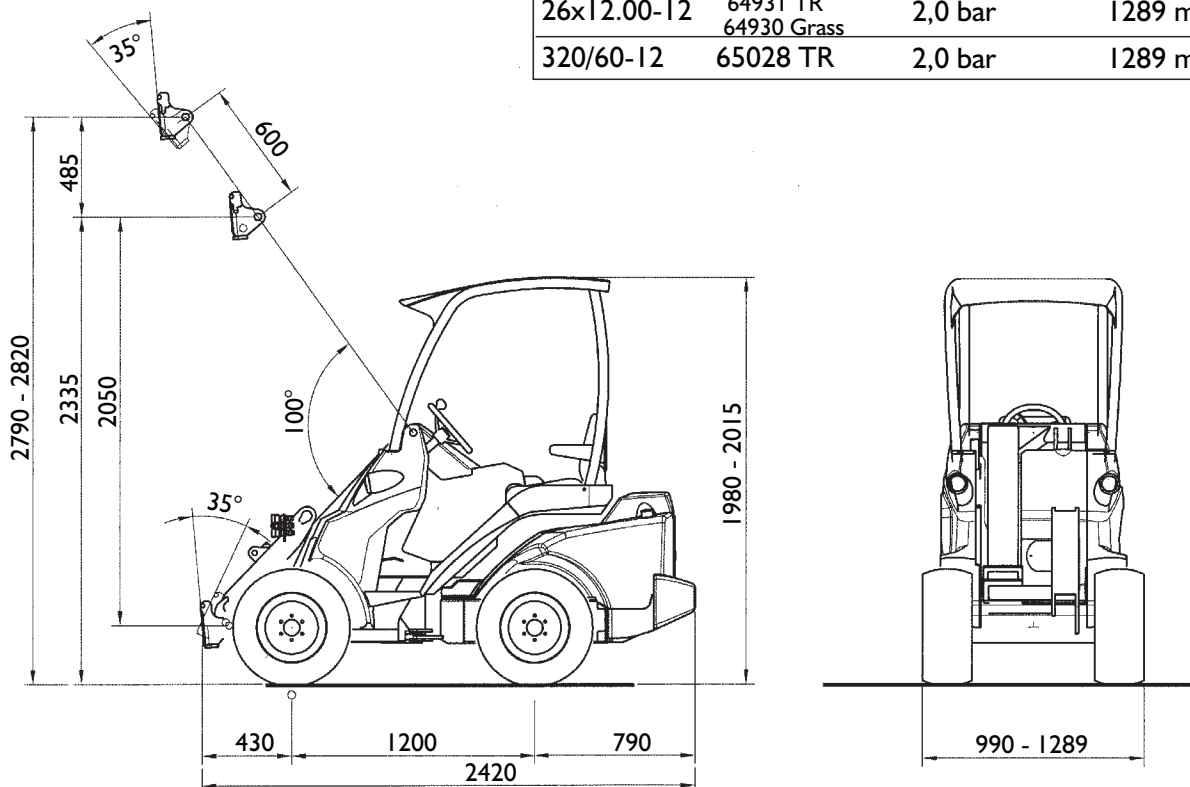

Load diagram

The lifting capacity of the loader is limited by the possibility of tipping around the front axle. The diagram below shows the tipping loads and max. allowed loads in different loading situations on an even level surface with the loader chassis in maximum articulation.

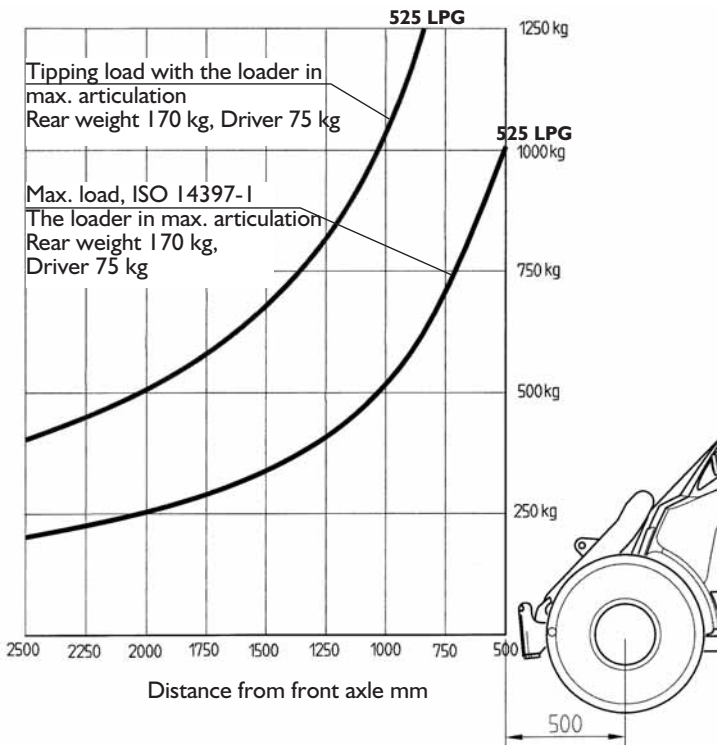

AVANT 525LPG load diagram

The diagrams can be interpreted as follows:

- The diagrams show tipping load and max. load with the load at different distances from the front axle of the loader
- Example: If the center of gravity of the load is 750 mm in front of the front axle, max. load is about 700 kg with a driver weighing 75 kg and with the 170 kg integrated rear weight mounted on the loader.
- **NOTICE:** If the driver leaves the machine, tipping and max. loads are reduced respectively.
- Tipping load and max. load depend both on the weight of the driver and the eventual extra weights mounted on the loader.
- Please note that the diagrams are based on the machine operating on a level, even and firm supporting ground. Loads should be significantly reduced when operating on gradients and/or on soft ground.
- The loader is equipped with a load sensor system, which gives an audible warning signal and an indicator lights up in the dashboard when tipping load is being approached.
- Read the safety instructions regarding handling of heavier loads. Calibration instructions of the load sensor system can be found on page 30.

Auxiliary hydraulics oil flow

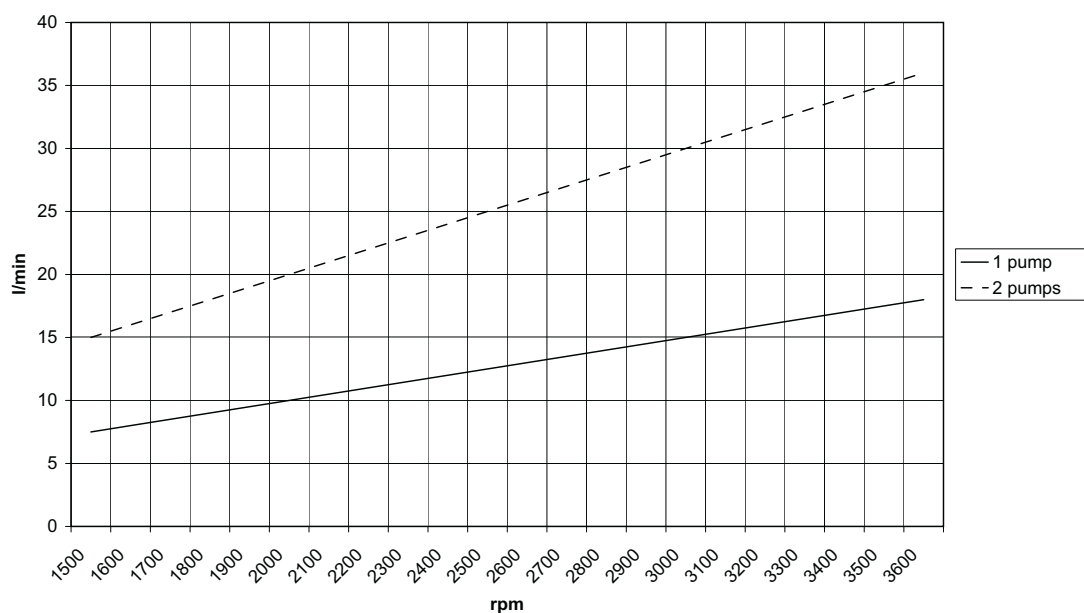

Max. auxiliary hydraulics oil flow can not be used with all attachments. Check correct engine rpm and auxiliary hydraulics pump configuration for the attachment with the help of this table and Operators Manual of the attachment.

Transporting instructions and tie down points

Mount the articulation frame lock, shown on page 26, on the machine during transports. Lower the boom down and take off battery disconnect switch.

Remember to remove the frame lock after transport!

Tie down points are located on the rear frame on the sides, and on the front frame close to the boom.

If absolutely necessary, the loader can be towed with a rigid tow bar, by releasing the hydraulic drive circuit. Max. allowed towing speed is 3 km/h, towing distance max. 200 m.



When the drive circuit is released for towing, the loader has no brakes. Before releasing the drive circuit make sure that the parking brake has been engaged, and release the parking brake only after a rigid tow bar has been connected.

The hydraulic drive circuit is released by turning the screw on the right side of the variable displacement drive pump about 3 rounds counterclockwise. Make sure to put the drive circuit again in working order by retightening the screw immediately after towing. Contact Avant service for instructions if necessary.

The loader can be lifted by mounting appropriate lifting slings on the ROPS frame. Before lifting, the attachment and eventual extra weights must be removed. Mount the frame lock on the machine. Make sure that the lifting slings cannot move and that the machine doesn't swing during lifting.

Operating instructions

Operating controls

Following picture shows the location of operating controls. The location and function of controls may be slightly different in different models, see following pages.



1. Steering wheel
2. Drive pedal, left: drive backward (page 16)
3. Drive pedal, right: drive forward (page 16)
4. Parking brake handle (page 16)
5. Control lever of boom and bucket (page 15)
6. Hand throttle lever (page 15)
7. Auxiliary hydraulics control lever (page 15)
8. Control lever of telescopic boom (page 15)
9. Control lever of rear / extra front auxiliary hydraulics (page 15)
10. Selector lever of auxiliary hydraulics pumps (page 15)
11. 12 V outlet
12. Dashboard (page 16)

13. Switches on the panel



Windscreen wiper and washer (cab option)

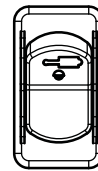

Hydraulic attachment coupling plate (option)



Work light (option)



Beacon (option)

Control of loader boom, auxiliary hydraulics and other functions

Most of the functions of the loader are controlled at the control panel on the right side of the operator: Boom and bucket movements, auxiliary hydraulics (attachments), engine revs etc. , depending on loader model. Following pictures show the different functions:



Attachment control switch pack (option)

- Optional extra with which electric functions of the attachment are controlled
- Does not require the optional 8 function joystick on the loader.
- Consists of socket that mounts on the boom. The electric harness of the attachment is connected to this socket, and the electric features are controlled with switches mounted on the boom control lever.
- Read the operator's manual of the attachment to see how the switches are used with each attachment.

5. Control lever of boom and bucket

(Functions of the optional electric joystick are explained on page 18)

- Pull backward to lift the boom
- Push forward to lower the boom
- Push left to raise the tip of the bucket (filling)
- Push right to lower the tip of the bucket (emptying)

6. Hand throttle lever

- Push forward to increase engine revs
- Pull backward to reduce engine revs

7. Control lever of auxiliary hydraulics (hydraulically operated attachments)

- Push forward: Hydraulic flow to pressure I coupler. Move the lever carefully to see which way the hydraulic attachment moves.
- Pull backward: the attachment moves in opposite direction
- Locking position: Continuous flow to pressure I coupler.

8. Control lever of telescopic boom (optional extra)

- Push forward to extend the boom
- Pull backward to retract the boom

9. Control lever of extra auxiliary hydraulics outlet (optional extra)

The control lever operates either the rear hydraulics outlet or the extra front outlet.









- Push forward + locking position: Move the lever carefully to see which way the hydraulic attachment moves.
- Pull backward: the attachment moves in opposite direction

10. Selection lever of the pumps for auxiliary hydraulics

- Lever in front position (1-pump): one pump coupled for auxiliary hydraulics
- Lever in back position (1-pump): both pumps coupled for auxiliary hydraulics

Dashboard

On the dashboard on the right side of the driver's seat are mounted gauges, indicators and switches which help the operator to control the loader. Dashboard may be slightly different in different models. Following picture shows the different functions:

1. Load sensor indicator 
2. Boom floating indicator 
3. Headlamp indicator (Road traffic light kit) 
4. Seat heater indicator 
6. Fuel gauge
7. Work light switch
8. Tachometer
9. Hour meter
10. Oil pressure indicator 
11. Charge indicator 
12. Thermometer
13. Ignition switch
14. Signal horn
15. Seat heater switch
16. Drive release / anti slip valve switch (optional extra)
17. Boom floating switch (optional extra)
18. Hydraulic cooler blower fuse indicator 
19. Worklight indicator 

Controls in the footwell

Following picture shows the controls located in the footwell

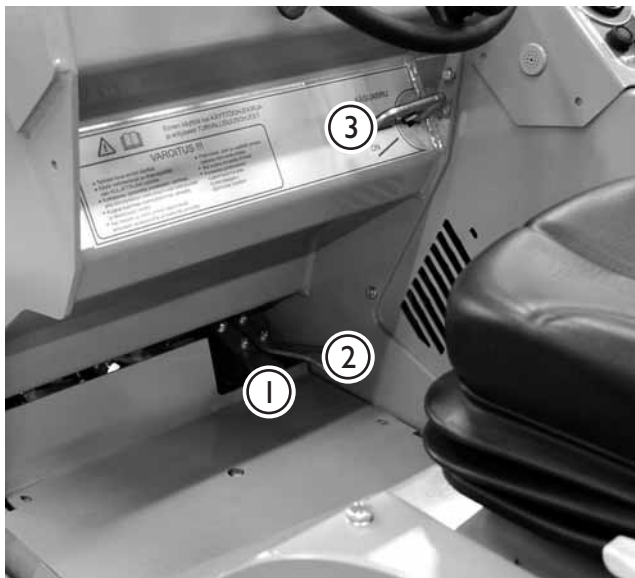

1. Drive pedal, left: drive backward
2. Drive pedal, right: drive forward
3. Parking/emergency brake handle
 - locking: pull the handle and turn down into locking position
 - releasing: turn up and let the handle go down



Parking brake locks mechanically - spring-loaded pins go into the holes of the parking brake drum on the front wheels. Make sure that the brake locks properly by driving a bit forward or backward.

See correct operation of drive pedals on page 20.



Suspension seat

The suspension seat is equipped with a seat belt and has the following adjustments:

1. Suspension adjustment

- by turning the lever clockwise suspension gets harder, by turning it counterclockwise the suspension gets softer

2. Angle of the back rest

- the angle of the back rest can be adjusted by pulling the lever

3. Seat position

- the distance of the seat from the steering wheel can be adjusted with the lever which is located under the front edge of the seat

Suspension seat can be equipped with a seat belt.



Telescopic boom (option)

Telescopic boom is operated either with the conventional control lever, or with the rocker switch on the joystick. Length of the telescope is 600 mm and additional lifting height is 485 mm.



Location of battery disconnect switch

The loader is equipped with a battery disconnect switch. The switch is located in the rear of the machine, on the right side (see picture). Battery disconnect switch cuts the current between battery and the rest of the electric system. Always switch off main current when the loader is not used for a longer period of time, or when servicing the machine. Switch off the main current in order that the battery doesn't get empty.



Boom self levelling (option)

Self levelling system keeps the position of the attachment the same in relation to the ground, regardless of the position of the boom.

Self levelling is hydraulic: there is a levelling cylinder on the left side of the boom which follows the movements of the bucket tilt cylinder and keeps the attachment level.

Self levelling is disabled when the boom floating is switched on.



Boom floating (option)

The floating system releases the lift cylinder, so that the boom floats upwards from the position where it is when boom floating is switched on, allowing the attachment to follow the contours of the terrain.

1. Lower the boom down
2. Switch on the floating with rocker switch no. (21)
3. Boom floating indicator on the dashboard lights up



When boom floating is being used, it is possible that air gets in the hydraulic system. This can lead to inaccurate boom movements and the boom can give in. Therefore the boom and attachment coupling plate should always be moved to extreme end positions after switching off boom floating. Use boom floating only when necessary.

Joystick (option)

The loader can be equipped, as an option, with a joystick, where the operation of auxiliary hydraulics and telescopic boom is electric.



1. Auxiliary hydraulics

- push the buttons to engage and disengage auxiliary hydraulics. The red switch directs hydraulic flow to the pressure I coupler.

2. Telescopic boom

- with the rocker switch the telescopic boom can be operated steplessly (extension- retraction). Speed of the telescoping function depends on the position of the pump selection lever.

Engine block heater (option)

The loader can be equipped, as an option, with an engine block heater. Engine block heater outlet is on the right side in the rear of the machine.



Use the block heater max. 30 minutes at a time.



Trailer coupling (option)

The loader can be equipped, as an option, with a trailer coupling. It is equipped with a 50 mm ball coupling and mounts either directly on the rear bumper or on the extra back weight.



Max. allowed vertical load of the trailer coupling is 6900 N, max. towing load is 6000 N.



Make sure that the weight on the trailer is distributed correctly so that the trailer cannot cause an upward lifting force on the trailer coupling

Extra weights (option)

The loader can be equipped with extra counterweights that are mounted on the rear bumper. Max. amount of extra weights (31 kg/pcs) is 4 pcs. If the machine is fitted with an extra weight with trailer coupling, max. amount of extra weights is 2 pcs.

Drive circuit release switch (option)

The switch no. 16, LOCK, controls a valve, which is used to divert the oil flow between left and right side hydraulic motors, and this affects the pulling force.



LOCK OFF: In this mode, the hydraulic oil flows in series from motor to motor. The wheels will roll more freely and the loader leaves less tire marks on soft surfaces.

LOCK ON: In this mode the hydraulic oil flows in parallel between the hydraulic motors in each side, similar to a differential lock in operation. This improves the towing capability of the loader.

If the loader is not equipped with a drive circuit release valve, the system will function as in lock on mode.

Anti slip valve (option)

The valve positively diverts oil flow between the right and left side hydraulic motors and improves traction on slippery and uneven surfaces. The function of the anti slip valve is connected to the drive circuit release switch:

LOCK ON: Anti slip valve in operation. Best traction is achieved by using sufficient engine revs and by pressing properly on the drive pedal.

LOCK OFF: Drive circuit released – anti slip valve diverts the oil flow between the front hydraulic motors only, not the rear hydraulic motors.

Work light kit (option)

The loader can be equipped with extra work lights, making it easier to work in low light. The lights are operated with the switch on the control panel (see page 14).

Snow chains (option)

The loader can be equipped with snow chains, following tyre size:

- 23 x 8.50-12 snow chain part no. 64746
- 23 x 10.50-12 snow chain part no. 64745
- 26 x 12.00-12 snow chain part no. 64973
- 320/60-12 snow chain part no. 65603

Tilt adapter (option)

The hydraulic tilt adapter mounts between the attachment and the attachment coupling plate. It allows the driver to tilt the attachment sideways 12,5 degrees to both directions from the driver's seat. Tilt adapter is intended mainly for non-hydraulic attachments, but with the optional double acting extra auxiliary hydraulics outlet in the front (A35462) it is possible to mount a hydraulically operated attachment (e.g. a 4 in 1 bucket) at the same time. In this case the tilt adapter is operated with the control lever no. 9 (see page 15).

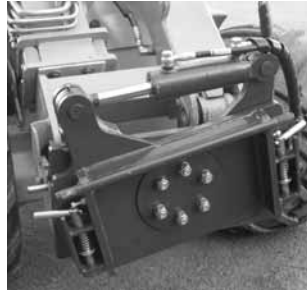

Extra auxiliary hydraulics outlets, front and rear (option)

In addition to the standard auxiliary hydraulics outlet, the loader can be equipped with a double acting extra outlet. The extra hydraulic outlet can be fitted either to the front of the loader or to the rear, and the couplers are conventional type quick couplers. The installed extra outlet is controlled with the lever no. 9 (see page 15).

The loader can be equipped with either the rear hydraulics outlet or with the extra front outlet – but not with both.

1. Extra auxiliary hydraulics in the front

- Quick couplers are located under the multi connector

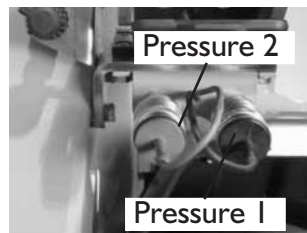

2. Quick couplers in the rear

- Quick couplers are located on top of the radiator.

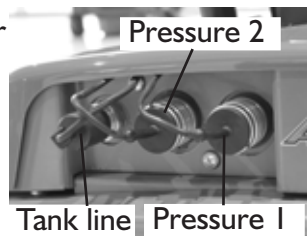

Double acting outlet

Single acting outlet

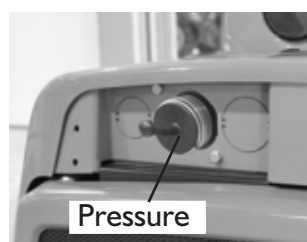

Starting the engine

Before starting the engine do the daily checks, see page 27. Adjust the seat and mirrors (if fitted) so that you have a good working position and unrestricted field of vision from the driver's seat. Check that all controls function correctly. See to it that the operating area is safe. Read and follow operating and safety instructions.



1. Turn the battery disconnect switch to ON



2. Open the gas bottle valve by 2-3 rounds



3. Move the hand throttle lever ① to approximately ¼ throttle
4. Make sure that auxiliary hydraulics is switched off (lever in neutral position). Do not press on the drive pedals.



5. Turn the ignition key ② to the right. If engine is cold, press on the choke button ③ and keep it down.
6. Turn the ignition key further to the right until the engine starts, then release the choke button.

If the engine doesn't start, do not try to start longer than 10 seconds at a time. Make sure that there is gas in the bottle, wait a little and try to start again. Press and release the choke button during starting. Do not try to start the engine if there is a strong smell of gas. Ventilate well before trying to start again..



If auxiliary hydraulics is switched on during starting and there is a hydraulically operated attachment on the machine, the attachment can move suddenly and cause a dangerous situation. Make sure that the auxiliary hydraulics control lever is in neutral position during starting.



The engine cannot start if either of the auxiliary hydraulics control levers is in its locking position (levers 7 and 8 on page 15).

Stopping the engine

1. Lower the boom down, reduce engine revs, stop the attachment (move auxiliary hydraulics control lever to neutral position, see page 15)
2. Stop the engine by turning the ignition key to the OFF position (to the left)
3. Release auxiliary hydraulics pressure (see page 15).
4. Close gas bottle valve
5. Prevent unauthorized use of the loader. Take off the ignition switch and turn the power off with the battery disconnect switch.

Before longer storage do the stopping by closing the gas bottle valve and letting the engine run until the gas pipes get empty and the engine stops.

Drive control



AVANT 500 series loaders are equipped with a hydrostatic drive system, there is a variable displacement hydraulic pump in the drive circuit. The oil flow of this drive pump is steplessly adjusted with the two drive pedals. The drive pedals act in a proportional way to control the drive speed and power available at the drive motors.

This hydrostatic driving system has different operating characteristics to a mechanical drive. To get maximum pushing power push the pedals lightly – for higher travel speed push the pedal harder.

When thinking about the function of the two drive pedals, they should be compared to gears, not to a conventional throttle pedal. The drive pedal in a way shifts on a higher gear the more the pedal is pressed. Therefore you shouldn't press the pedal more when the engine starts to struggle. Pressing the pedal just causes the engine to stop.

When you want to have a high pulling force:

1. Use high engine revs
2. Select a relatively slow drive speed with the drive pedal. That is: press the pedal only lightly (= select a low gear). This way the full output of the hydraulic system and the engine can be taken out.

Driving of the machine is **controlled with the drive pedals and hand throttle** as follows:

Select the revs of the engine with the **hand throttle lever** on the control panel. The basic rule is: use lower revs for lighter work and higher revs for hard work. When driving, the revolution speed of the engine can be adjusted with the hand throttle lever, if necessary. Do not turn the machine with a high travel speed. Hand throttle also has an effect on the operation speed of a hydraulically driven attachment: the more throttle the faster the attachment operates. Make sure not to exceed max. allowed oil flow of the attachment.

If you want to **drive forward**, press gently on the **right** drive pedal until the machine starts to move slowly. The desired drive speed is selected with the drive pedal: the more the pedal is pressed the faster you will travel.

When you **wish to stop** gently release the pedal by lifting of your foot, and the machine will slow and stop.

Drive backward is controlled with the left drive pedal in the same way as drive forward: the more the pedal is pressed the faster you will travel.

Familiarise yourself with the driving of the machine on low speed and on a flat, even and open place where unintended movements don't cause problems or danger. When you have learned how to drive on low speed, increase speed gradually and learn how to drive with higher drive speeds. Make sure that there are no persons in the operating area of the machine.



Hydraulic oil temperature has an effect on the hydrostatic transmission of the loader. When ambient temperature is below 5° C, let the engine run and the machine warm up properly before starting to drive. Drive carefully until the machine reaches its normal operating temperature.



When hydraulic oil gets warmer, driving characteristics of the transmission change. When the oil is warm and hydraulic oil cooler has switched on, stopping distance of the machine can be longer than normally. If the machine is used constantly in high ambient temperatures, hydraulic oil type and viscosity must be suitable for these conditions. Contact Avant service.



Should there be a disturbance or malfunction in the hydrostatic transmission and consequently the braking force is not sufficient, engage the mechanical parking brake. Parking brake can also be engaged during driving if necessary.

Steering of the machine

Steering of the machine happens with the steering wheel. The steering wheel is hydraulically powered. A practical way of steering is to steer with your left hand on the knob of the steering wheel. This way your right hand is free to operate other functions.



Always remember – safety first. Test all the functions of the loader at an open and safe place. Make sure that there are no persons in the operating area of the machine and the danger zone of the attachment.



When driving, always keep the loader boom as low as possible. Risk of tipping over increases considerably when there is a heavy load on the loader (a heavy attachment or a big load in the bucket) and the boom is up when driving.



Never use a high drive speed when turning. In particular: when the loader boom is up the stability of the machine is much weaker when turning.



Remember that, when turning, the driver's seat extends beyond the turning radius of the wheels. Stay inside the safety frame (risk of collision and crushing).

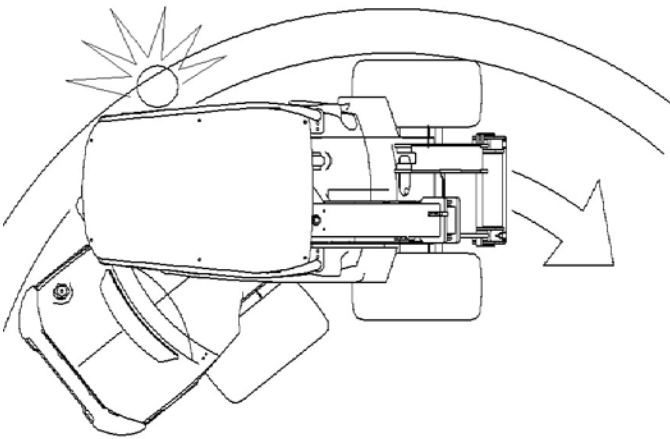

Pay attention to other machines and persons that are moving in the area. Make sure that there are no persons in the danger zone of the loader and the attachment. The danger zone of the loader covers the reach area of the loader boom, the turning area on the side and in the front and rear of the loader. Always put down the load when leaving the machine – the loader is not designed to stay with the loader boom and load lifted. Learn how to operate the loader in a safe place.

Loader control

The loader boom and bucket are controlled with the multi-function lever sideways (tilt) and back & forward (boom up & down).

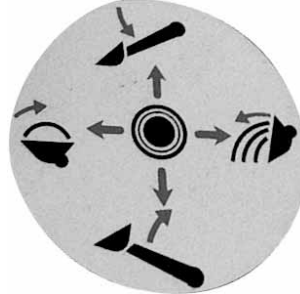

- Pull backward to lift the boom
- Push forward to lower the boom
- Push left to raise the tip of the bucket (filling)
- Push right to lower the tip of the bucket (emptying)

Using the auxiliary hydraulics

Auxiliary hydraulics (hydraulically operated attachments) are controlled with the lever no. ⑦ on the control panel, or with the buttons on the joystick (see page 18). The lever locks in the locking position (on the right) which facilitates operation of the attachments that require constant oil flow (rotary broom, backhoe etc.).



NOTICE! The engine cannot start if the auxiliary hydraulics control lever is in the locking position.



If the loader is equipped with conventional quick couplers, operating direction of the attachment depends on the coupling of the attachment hoses and the direction in which the auxiliary hydraulics control lever is moved. Make sure that there are no persons in the danger area when testing the operating directions. Change the place of the hoses if necessary.



Going near an attachment that is in operation can cause a serious risk. Switch off auxiliary hydraulics before leaving driver's seat or stopping the engine. Operate the controls only when sitting in the driver's seat.

Cabs

AVANT 525LPG can be equipped, as an option, with cab L or LX.



Cab L mounts on the ROPS safety frame. It consists of windscreen, windscreen wiper and washer, right side window and rear window.



Cab LX consists of windscreen, windscreen wiper and washer, right side window, rear window, door and heater.

Switches are located on the control panel right (see page 14). Heater temperature adjustment on cab LX is located in the footwell left.

Windscreen washer tank and filler cap are located outside the cab, in front of the windscreen on the left.

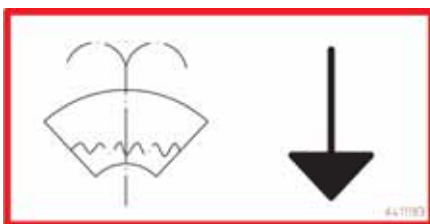

Windscreen washer tank and filler cap + decal.

Heater



Temperature adjustment

Fan

Filter

Cab LX is equipped with a warm water heater which works like a central heating system, circulating the coolant of the engine. Cab temperature can be adjusted with the rotary switch of the heater. Air flow can be directed with the nozzles on the front panel and in the footwell. Heating efficiency and air flow can be adjusted with the fan.

The cab is also equipped with an air circulation system: There is a ventilation hatch below the seat in the footwell. The hatch is opened and closed with the lever in the middle. As soon as the hatch is opened the heating system starts to take warm air from the cab and circulates it through the nozzles back in the cab. This way the cab warms up quicker in cold weather.

NOTICE: Switch off the air circulation as soon as the temperature in the cab is sufficient, otherwise moisture starts to condense on the windows.

The cab is also equipped with a replaceable cab air filter. The filter cartridge (part no. 65118) can be changed from outside the cab, under the door on the left side (see picture above)



Do not drive with the cab door open, nor turn the steering wheel when the cab door is open. The door may break.

Safety

Familiarise yourself with the special drive features and space needs of this articulated loader, equipped with cab, on a flat, even and open place. Remember that, when turning, the cab extends beyond the turning radius of the wheels. This should be taken into consideration especially when driving in confined spaces, in order that the rear of the cab will not get damaged.

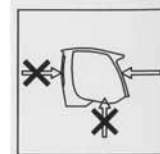

If necessary, the windscreen can be broken with the emergency hammer in the cab. This way it is possible to get out of the cab in an emergency situation.



The fuse box on machines with cab LX is located outside the cab, on the right side below the windscreen.

Requirements for attachments

- Check max. allowed hydraulic oil flow for the attachment. Adjust engine revs and auxiliary hydraulics pumps (selection lever: 1 or 2 pumps) so that they are suitable for the work and the attachment.
- Read Operators Manual of the attachment before starting operation. Make sure that the attachment is compatible with the loader. Contact your Avant dealer if necessary
- Make sure that the attachment is connected properly on the attachment coupling plate, and that it is being used in accordance with the instructions in the Operators Manual. Follow instructions regarding personal protective equipment and safety distances.
- Put the attachment down on the ground and stop the engine before leaving driver's seat. Familiarise yourself with the operation and stopping of the attachment at a safe place. Follow service instructions.

Coupling the attachments



Coupling of the attachments into the attachment coupling plate happens as follows:

Stage 1 :

- Lift up the two locking pins on both sides of the attachment coupling plate and turn them backward so that they remain in the up position
- Make sure that the pins remain in the up position, otherwise you cannot couple the attachment properly!



Stage 2 :

- Turn the attachment coupling plate with the tilt movement so that the upper edge of the plate leans forward.
- Drive the loader into the attachment



Stage 3 :

- Lift the boom a little so that the attachment lifts off of the ground
- Pull the boom control lever to the left so that the lower edge of the attachment coupling plate turns into the attachment



Stage 4 :

- Pull the boom control lever more to the left so that attachment coupling plate turns more and the brackets on the boom push the pins down in the holes of the attachment.
- Make sure that the pins lock properly down in the holes of the attachment!

Hydraulic attachment coupling plate (option)



Always make sure that the locking pins lock properly down in the holes of the attachments. Both pins must be locked. Avoid unintentional dropping of the attachment. Operate the hydraulic coupling only when the attachment is close to ground.

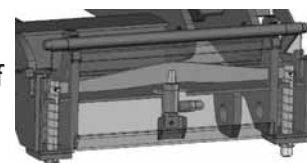

The hydraulic attachment coupling plate enables coupling and disconnecting of the attachment from driver's seat. There is a hydraulic cylinder on the attachment coupling plate which moves the locking pins up and down. The electro-hydraulic system works also when the engine is not running, as long as the ignition switch is in "ON" position (current on). Control switch is located at the control panel on the right (see page 14).

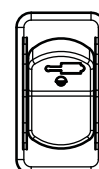

Switch up:
Locking released
Switch down:
Locking position

Coupling the hydraulic hoses of the attachment

Hydraulic hoses of the attachment are equipped either with the multi connector or with conventional type quick couplers. Contact your Avant dealer if you wish to change the coupler type.



Coupling the multi connector

Align the pins of the attachment connector with corresponding holes of the loader connector. Connecting is not possible if the multi connector for some reason is mounted in a wrong way on the attachment hoses. Connect and lock the multiconnector by turning the lever towards the loader.

The lever should move easily all the way to locking position. If the lever doesn't move easily, check alignment and position of the attachment and loader side connectors and clean the connectors. Stop the engine and release pressure in auxiliary hydraulics line by moving the auxiliary hydraulics control lever in both directions a couple of times.

Disconnecting the multi connector

- Before disconnecting put the attachment down on a solid and even surface. Switch off auxiliary hydraulics. Disconnect attachment hoses by pressing on the red button on the multiconnector and simultaneously turn the lever away from the machine.



Conventional type quick couplers

- Engine must be stopped when connecting the hoses. Before connecting the hoses move the auxiliary hydraulics control lever in both directions a couple of times in order to release eventual back pressure.



NOTICE! When fitting an attachment, make sure that the hydraulic hoses are not overstretched and are not in a position where they can be trapped during the operation of the machine and attachment.



Make sure that the attachment is properly connected on the attachment coupling plate. An attachment that comes loose may tip over or fall on the loader, causing personal injuries.



Do not try to lock the locking pins by using the brackets on the boom when the attachment is lifted over one metre from the ground. Lock the locking pins by hand and make sure that both pins lock properly down in the holes of the attachment.



Always read also the additional instructions for coupling and using of the attachment in the Operators Manual of the attachment.

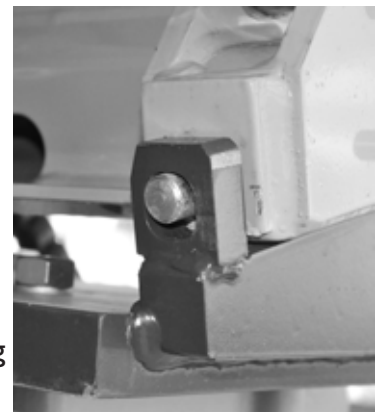

Service and maintenance instructions

Service parts are available through your Avant dealer or authorized service.



If you are not sure about how to do any service operation, ask for additional information before starting servicing. Contact Avant service.

Safety instructions for maintenance

- Stop the engine and let it cool down before starting any service operation.
- Put the service support on the boom lift cylinder when working under the boom.
- Install the frame lock when lifting the machine, for instance when changing tyres



Check hydraulic hoses and components only when the engine is stopped and hydraulic pressure is released. Repair all leaks as soon as you have noticed them, because a small leak can quickly change into a big one. Do not operate the machine if you have noticed faults or leaks in hydraulic system. Leaking hydraulic fluid can cause serious personal injuries and is harmful to the environment.

Check hydraulic hoses for eventual cracks and wear. Follow the wear of the hoses and stop operation if the outer layer of any hose has worn out. If there are signs of oil leakage, put a piece of cardboard under the probable leakage place in order to find the leakage. If you find a fault, the hose or the component must be replaced. Contact your Avant dealer or service for spare parts.



Never handle pressurized hydraulic components, because ejection of high pressure hydraulic fluid can cause serious injuries. Do not operate the machine if you have noticed a fault in the hydraulic system. Consult a doctor immediately if hydraulic fluid penetrates your skin.



Installing of service support and frame lock

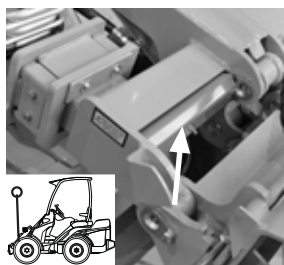

The red service support of the boom lift cylinder is located at the tip of the boom, behind the attachment coupling plate. The frame lock is located over the articulation joint, under the seat base, and is fastened with a bolt.

Make sure that the boom stays up during maintenance operations by putting the service support on the lift cylinder piston rod. Secure the service support by locking it on the piston rod with the long screw that is on the support.

The frame can be locked with the red frame lock. This way the loader frame stays straight during e.g. transportation. Install the frame lock in the holes on the front and rear frame and secure it with the cotter pin.

Releasing the pressure of hydraulic system

Make sure that there isn't pressure in the hydraulic system that could cause danger during service operations.

In order to release the pressure in hydraulic system stop first the engine and lower the boom down completely. Move all control levers, including control lever of telescopic boom and auxiliary hydraulics, to extreme end positions a couple of times. Remember that the boom or attachment can move when releasing the pressure. Move the levers until all movements have stopped.



Wear protective glasses and gloves when servicing the machine.



The fluids in the machine are harmful to the environment. Take waste oil and fluids to recycling station.

Daily inspections

- Tyre pressure
- Boom movements
- Drive control and steering
- Eventual need for lubrication
- Cleanliness of engine compartment and radiators
- Eventual oil leakages
- Locking of attachment and locking pins on attachment coupling plate, function of attachment, position of attachment hoses
- Condition of the loader, safety frame, seat belt and other safety equipment

Maintenance schedule

Following table shows the maintenance and service points and intervals. There are more detailed instructions about each service operation, in numerical order, on the following pages.

Loader	Every week	After 50h	Every 200 h/year	Every 800h
1. Check tyre pressure	■			
2. Clean the machine	■			
3. Grease the machine	■			
4. Check battery electrolyte level			●	
5. Check hydraulic oil level	●			
6. Change hydraulic oil filters		●	●	
7. Change hydraulic oil		●	●	
8. Check tightness of bolts, nuts and hydraulic fittings		●		
9. Check pressure of hydraulic system *)		■	●	
10. Adjust pressure of hydraulic system *)		■	■	
11. Check slide pads 1 and 2 on the boom	●			
12. Adjust or change slide pads 1 and 2		■	●	
13. Check/change slide pads 3, 4, 5, 6, 7 and 8			■	●
14. Calibrate load sensor			●	
15. Change gas system pre filter			●	
Engine*)				
16. Check engine oil level	●			
17. Change engine oil		●	●	
18. Clean air filter			●	
19. Check gas bottle			●	
20. Check condition and tightness of alternator belt			●	
21. Check water hoses and hose clamps			●	
22. Change engine oil filter		●	●	
23. Clean radiator cells	●		●	
24. Change coolant			●	
25. Change air cleaner element	●		●	
26. Check and adjust valve clearances				●

● Maintenance operation

■ When necessary

*) A 250 bar pressure gauge, equipped with manometer fitting, is required for checking the pressure of the boom lifting and auxiliary hydraulics.

2. Cleaning of the loader

Cleanliness of the loader is not only a question of outer appearance. All surfaces, painted and others, will stay in better condition when they are cleaned regularly. A clean machine also lasts longer. A dirty machine will run hotter and will collect dirt into the air cleaner, which is likely to damage the engine. Pay special attention to the cleanliness of the engine, the oil tank cover, the engine compartment and the hydraulic pump compartment.

The loader can be washed with a pressure washer. However, avoid direct spraying on hydraulic components (hoses, cylinders) and decals. After washing grease all greasing points, also the attachment coupling plate and locking pins.

The loader is equipped with a hydraulic oil cooler, which is located in the front frame on the right side, make sure to clean the oil cooler cell with compressed air every time you are servicing the loader - and even more frequently if the loader is being used in dusty conditions. Take off the right side cover plate before cleaning the oil cooler.



3. Greasing of the machine

Greasing of pivot points is very important in order to avoid wear. Most of the greasing points are on the loader boom. The picture on page 31 shows the location of grease nipples.

4. Battery check

In order to secure the starting and safe operation the battery of the loader must be checked regularly. Checking the electrolyte level of the battery happens by opening the filler caps. **NOTICE: Clean the battery before opening the caps so that dirt cannot get in the battery.** Check also the contacts and clean if necessary.

5. Hydraulic oil level

Hydraulic oil level can be checked with the dipstick in the filler. Oil level should be at the lower mark of the dipstick when the loader boom is up. Refill when necessary. Do not let any contaminants enter the hydraulic oil tank during this procedure. There is a breather filter inside the dipstick cap which should be cleaned or changed once a year.

Remember to use the service support (page 26).

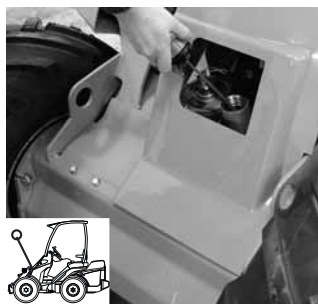

6. Changing of hydraulic oil filters

The hydraulic oil return filter is located on top of the hydraulic oil tank, under the front cover. Take off the cover and replace the oil filter cartridge.

Remember to use the service support (page 26).

The hydraulic pressure filter is located in the back frame beside the hydraulic pumps. When unscrewing the filter hold the screw in the housing with a 12 mm allen key and replace the filter.

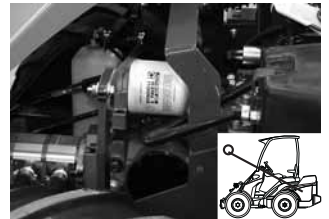

7. Hydraulic oil change

When changing hydraulic oil, the oil can be removed with a suction pump or by opening the drain plug on the right side of the front frame, next to the articulation joint. In both cases it is important to clean the magnetic drain plug. Hydraulic oil tank capacity is 38 litres. Use ISO VG-46 certified mineral hydraulic oil.

Use of synthetic hydraulic fluids is not allowed.



8. Check and tightening of bolts, nuts and fittings

Check tightness of bolts, nuts and hydraulic fittings regularly.

NOTICE: Tighten wheel nuts after first 5 operating hours. Check tightness of wheel nuts regularly. Wheel nuts shall first be tightened to 120 Nm diagonally opposite and finally tightened to 140 Nm.



9. Check pressure of hydraulic system

Pressure checking points and pressure settings for different functions are as follows:

Boom lifting: Pressure is checked from the manometer fitting which is mounted on the main control valve (or from the quick coupler of rear auxiliary hydraulics if the machine is equipped with rear aux. hydraulics outlet.)

Pressure is measured with full engine revs and by turning e.g. the bucket tilt control to end position. Pressure setting should be 205 bar.

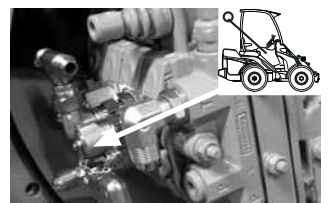

Auxiliary hydraulics: Pressure is checked from the measuring point, with full revs and by turning the aux. hydraulics control lever. Pressure setting should be 200 bar.



Drive pressure: In order to check the pressure in the drive circuit one needs to mount a pressure gauge in the pressure line in each and every case, if pressure seems to be clearly wrong. There are two pressure relief cartridges (one for drive forward, one for drive backward) which have fixed 300 bar pressure setting

It is recommended that pressures should only be checked by a competent and experienced technician. Call your AVANT dealer if you need assistance.

10. Adjust pressure of hydr. system

If the pressure of hydraulic system does not seem to be correct or pressure check indicates that the pressure is wrong, it can be adjusted. All adjustment screws are protected with a 13 mm nuts and there is a seal ring under each nut. When taking off the nuts make sure that the seal rings doesn't get lost. Adjust the pressure with an allen key, max. 1/8 rounds at a time. See pictures for pressure adjustment points.

Boom lifting: Pressure is adjusted from the pressure relief valve at the main control valve. Pressure adjustment screw is on the right, on top of the valve segment (see picture). Adjust by turning the hexagonal head screw which is under the cap.

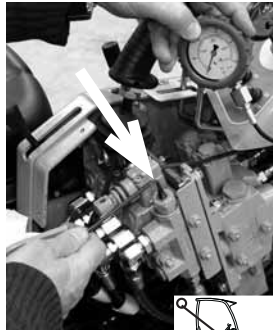

Auxiliary hydraulics: Pressure is adjusted from the pressure relief valve at the main control valve. Pressure adjustment screw is on the right, under the valve segment (see picture). Adjust by turning the screw with a screwdriver.

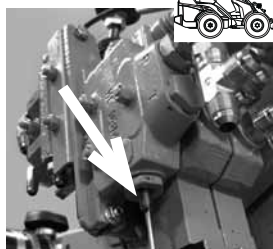

Drive pressure: Can not be adjusted. If the pressures are clearly wrong one must change the pressure relief cartridges which have 300 bar fixed pressure setting.



Never exceed the recommended hydraulic pressure settings. Excessive hydraulic pressure will damage the hydraulic pumps, cylinders, and hydraulic motors.



Warranty does not cover damages caused by excessive hydraulic pressure.

11-13 Adjust and change the slide pads on telescopic boom

The telescopic boom is equipped with slide pads. At the lower end of the outer boom there are slide pads made of nylon (nos. 1 and 2) and bronze (nos. 3 and 4). In addition, there are four slide pads (nos. 5, 6, 7 and 8), made of aluminium-bronze alloy, at the upper end of the inner boom. All slide pads can be replaced, and the nylon slide pads on the outer boom can also be adjusted. This way the natural wear of the slide pads, caused by the use of the telescopic boom, can be compensated.

Slide pads nos. 1 and 2 can be adjusted by mounting thin adjustment sheets between the boom and the slide pad. Extend the telescope almost completely and press the boom against the ground, it is the easiest way to mount the adjustment sheet under slide pad no. 2. However, if there is substantial wear in the slide pads it is advisable to replace both pad no. 1 and 2.

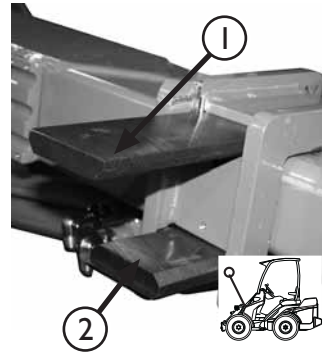

Slide pads nos. 3 and 4 on the side of the outer boom and **slide pads nos. 5, 6, 7 and 8** at the upper end of the inner boom last very long in normal use. Slide pads 3, 4, 5, 6, 7 and 8 should be checked every 400 operating hours. Checking happens by taking the inner boom completely out of the outer boom. If the pads have worn so much that they are level with the boom, change the pads.

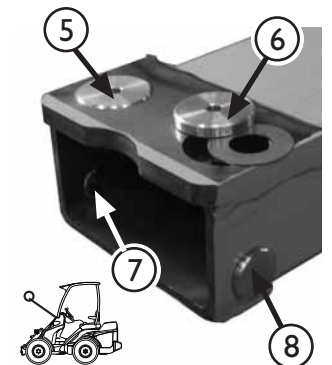
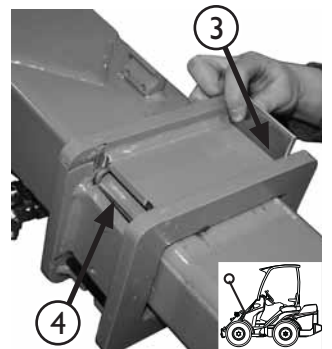

Part nos. for the slide pads are:

- Slide pad 1 and 2: A48339
- Slide pad 3 and 4: A48340
- Slide pad 5 and 6: A47922
- Slide pad 7 and 8: A48343
- Washer under slide pads 5 and 6: A47941
- Adjustment sheet, short: A48013
- Adjustment sheet, long: A48014

14. Function and calibration of load sensor

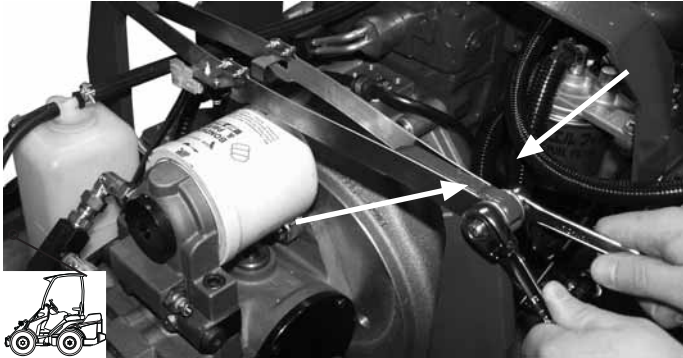

The load sensor must be calibrated in case one adds or removes more than two AVANT rear weights (+/- 65 kg) on the machine. Calibrating happens as follows:

1. Mount the amount of rear weights with which you are going to use the loader.
2. Remove the engine cover plate and the lower left side rear cover plate.
3. Lift something so heavy with the loader that the rear wheels lift off the ground.
4. Open the screw pointed by the arrows (see picture) with two 13 mm keys. As the two steel strips come in contact, tighten the screw.
5. Lower the rear wheels back to the ground and mount the cover plates.
6. Check function of the load sensor.

NOTICE: The rear of the loader can not be lifted with a jack in order to do the calibration. The rear wheels must be lifted by using the loader boom in order that the adjustment can be done correctly.

15. Change of LPG system pre filter

The pre filter of LPG system must be changed every 200 hours, see page 31. If composite or steel gas bottle is being used, the filter must be changed more frequently.

16.-29. Service, engine

AVANT 525LPG is equipped with a Kubota LPG engine (see technical specification sheet for the engine type). Service and maintenance instructions for the engine can be found in the Kubota Operator's Manual supplied with the loader.

Fuse box

The fuse box is located on the right side of the loader boom, seen from driver's seat.

Fuses can be checked by first lifting the boom so that the fuse box can easily be reached. Remember to use the service support.

The list on the right shows the location and function of each fuse in the fuse box.

If the engine does not run and the boom cannot be lifted, the fuses can be checked after removing the right side cover plate.

The red indicator no. 18 on the dashboard indicates blown hydraulic oil cooler fan fuse. If the indicator is lit, check the 25A fuse of the oil cooler fan. Contact Avant service if necessary.

25A	Hydraulisen öljyn viilintila
25A	Takavarmen
20A	
10A	Hydraulisen öljyn viilintila
30A	Hydraulisen öljyn viilintila
15A	Hydraulisen öljyn viilintila
25A	Hydraulisen öljyn viilintila
10A	Hydraulisen öljyn viilintila
20A	Hydraulisen öljyn viilintila
20A	Hydraulisen öljyn viilintila
25A	Hydraulisen öljyn viilintila
15A	Hydraulisen öljyn viilintila

Jump start and auxiliary power

The engine can be started with auxiliary power if necessary, by using appropriate (strong enough) jump start cables. Connect first one end of the positive cable to the positive (+) post of the dead battery. Then connect the other end of the positive jumper cable to the positive (+) post of the charged battery. Connect one end of the negative jumper cable to the negative (-) post of the charged battery. Then connect the other end of the negative jumper cable to a solid, non-paint coated metal part of the engine of the dead loader, as far from the dead battery as possible.



Read Operators Manual of the vehicle that is giving auxiliary power, in order to make sure that the vehicle suited for that. The vehicle can get damaged when giving auxiliary starting power.

Safety instructions when handling the battery

- Battery contains corrosive sulfuric acid.
- Avoid contact with skin or clothes. If electrolyte gets on your skin or clothes, flush with a lot of water.
- In case of contact with eyes, flush with a lot of water for at least 15 minutes and consult a doctor immediately.
- When charging the battery gives off potentially explosive gases – do not smoke when handling the battery.
- In order to avoid spark emissions always disconnect the negative (-) cable first and connect it last
- Before connecting the battery cables make sure that the polarity is correct: faulty connection will seriously damage the electric system of the engine.

GREASING POINTS

Following pictures show the location of greasing points.

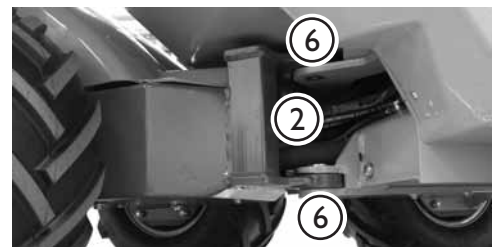
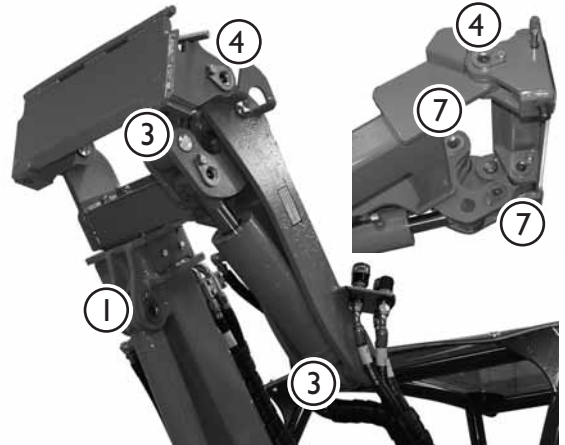
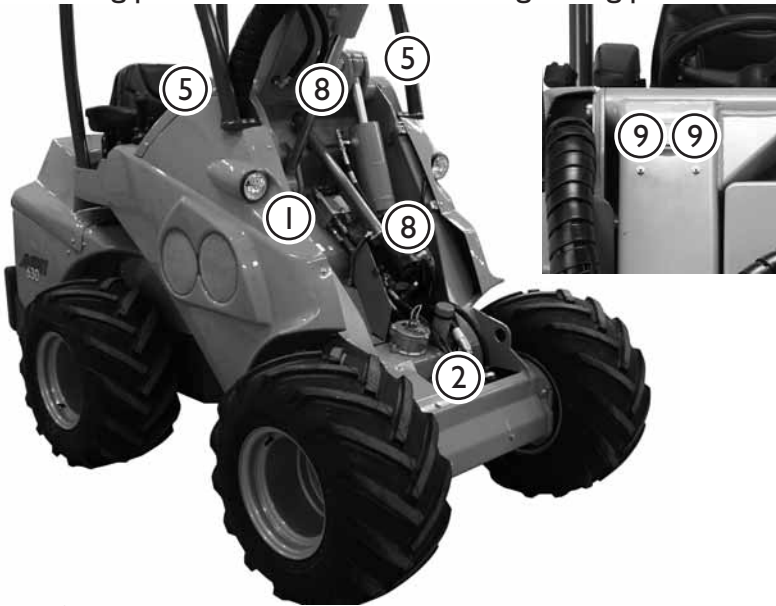

- | | |
|--|--|
| <ol style="list-style-type: none"> 1. Lift cylinder, both ends 2. Steering cylinder, both ends 3. Tilt cylinder, both ends 4. Pivot pins on attachment coupling plate/boom | <ol style="list-style-type: none"> 5. Pivot pin on loader boom 6. Articulation joint 7. Tilting mechanism 8. Leveling cylinder, both ends 9. Telescopic boom, grease with boom completely retracted |
|--|--|



Check the tightness of the pivot pin locking screws, if loose tighten and use thread locker.

LPG system, parts

Following pictures show the main parts of LPG system.

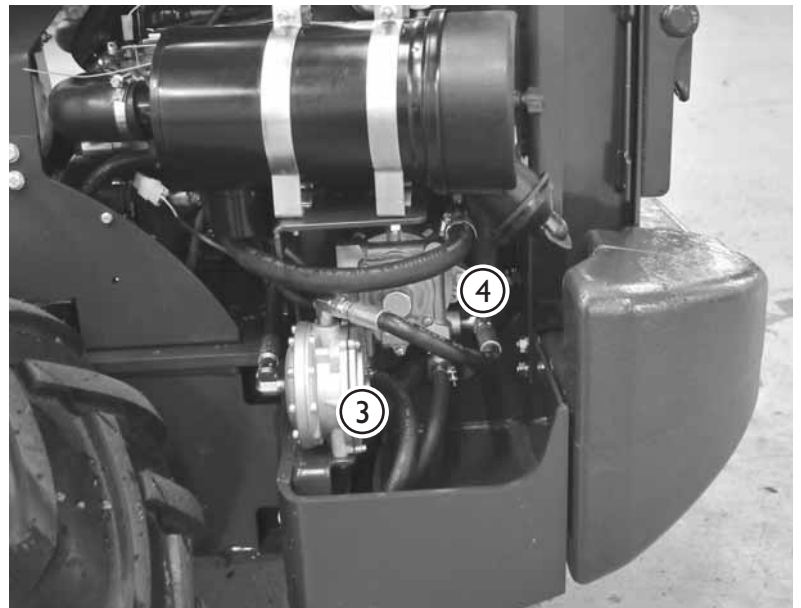
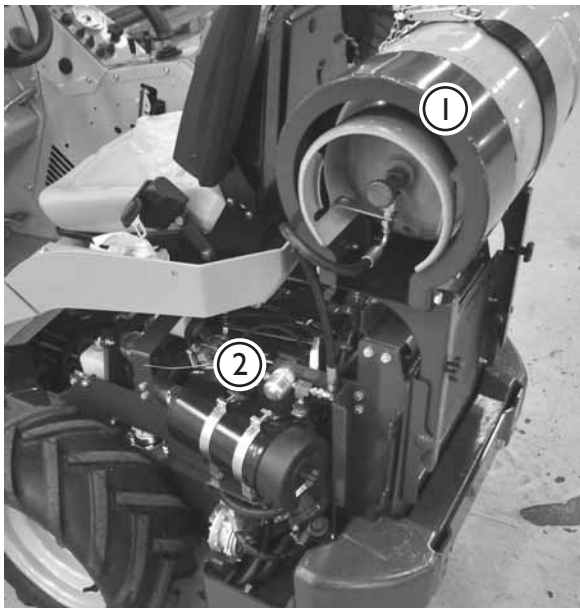

1. Gas bottle
2. Pre filter (part no. 65487)
3. Vacuum pressure safety valve / filter (not replaceable)
4. Vaporizer

Service the LPG system only when the engine is not running, the gas valve is shut and there is no gas in the pipes. More demanding service operations can only be done by a professional and experienced LPG expert.

Filters

Following pictures and tables show the location and part numbers for the filters..

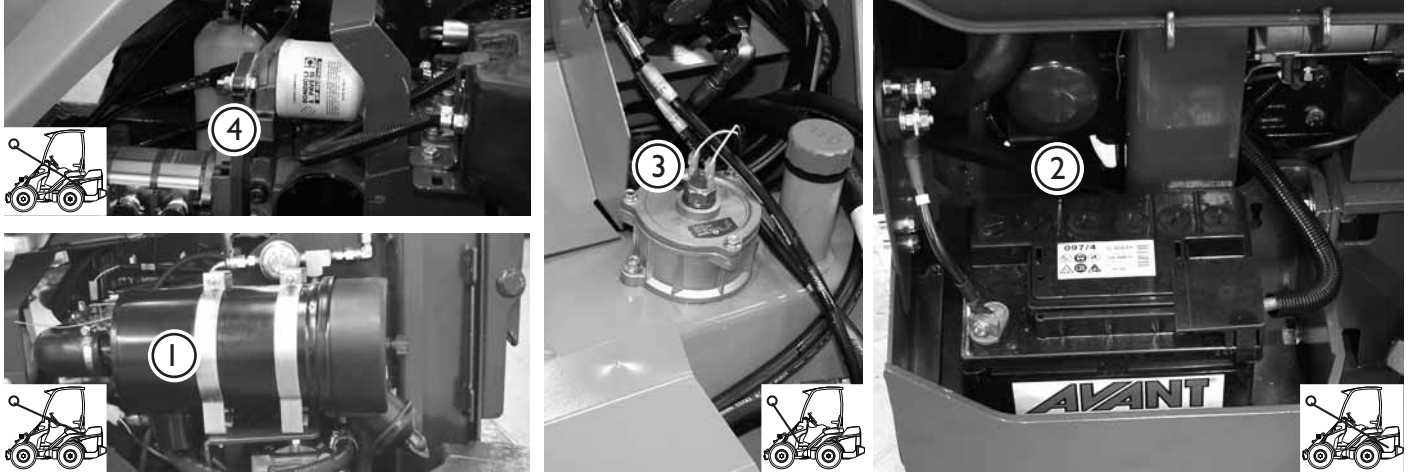

AVANT 525LPG filters

1. Air filter
2. Engine oil filter
3. Hydraulic oil filter, return
4. Hydraulic oil filter, pressure

Part numbers, filters

Filter kit A414037 includes:

- 64956 Air filter
- 64627 Engine oil filter
- 74093 Hydraulic oil filter, return
- 64807 Hydraulic oil filter, pressure
- 65487 LPG filter

Light bulbs

Part no. for standard front light bulb and work light bulb is 64874.

Metal structures of the loader



Contact Avant service in case the steel structure of the loader gets damaged. A faulty reparation can cause a dangerous situation.

In case the ROPS safety frame or the FOPS canopy of the machine gets damaged, the machine must be taken to Avant service for checking. It is not allowed to repair the ROPS and FOPS.

Storage of the machine

Before long term storage clean the loader carefully and check and touch-up painted surfaces if necessary in order to avoid rust damages. Grease the greasing points and put oil on piston rods of the cylinders. Take off the battery and store it in the right way. It is recommended to perform the yearly service before storage. Close the gas valve and let the engine run until all gas runs out from the pipes. Take off the gas bottle and store it in upright position in a cool, dry place; protected from heat and sun. Cover well the end of the gas hose also.

Troubleshooting

Below is a listing of most common problems and the solutions for them. More options concerning the engine can be found from the operator's manual of the engine.

Problem	Cause	Remedy
Hydraulic attachment does not work when the auxiliary hydraulics control lever is moved NOTICE: This concerns only machines with conventional type quick couplers. If the loader is equipped with the multi connector and the hydraulic attachment doesn't work, the hoses of the attachment or the machine multi connector are mounted on wrong fittings. Check and correct, contact Avant service if necessary.	Attachment hoses are not coupled or they are coupled wrongly in the quick couplers. Attachment hoses are not coupled or they are coupled wrongly in the quick couplers.	Make sure that the hoses are properly connected into the quick couplers, change the place of the hoses if necessary. Auxiliary hydraulics have double acting pressure couplers (female) and a return line (male coupler) Operating direction of the attachment depends on how the hoses are connected in the quick couplers. Replace quick couplers.
Engine doesn't rev up or runs unevenly	Not enough gas in the bottle. Gas valve not opened enough. Gas filters clogged.	Change new gas bottle. Open the valve 2-3 rounds. Change LPG filter. Clean or change strainer at the end of gas hose.
Engine does not start.	Auxiliary hydraulics control lever is in locking position. Gas valve closed or gas bottle empty. Battery empty or damaged, or battery disconnect switch is switched off. Blown fuse no. 3 (fuses in the fuse box are numbered).	Turn the lever in center (neutral) position. Open the gas valve and make sure there is gas in the bottle. Turn battery disconnect switch to ON, check charge of the battery. Change the fuse.
Attachment hoses will not go into the quick couplers of the machine (concerns only machines with conventional type quick couplers).	There is back pressure in the auxiliary hydraulics line.	Release the pressure by moving the auxiliary hydraulics control lever in both directions.
The machine moves after parking brake has been engaged.	The pins of the parking brake mechanism have not locked properly in the wheels. Parking brake engages the front wheels.	Drive slowly forward or backward in order to lock the parking brake. When releasing the parking brake do this in opposite order. If the machine must stay in a slope, park it so that the heavier end is on downhill side.
There is a strong smell of gas.	Leakage in gas system.	Stop the engine immediately, close gas valve and switch of battery disconnect switch. Change faulty components, contact Avant service.

SERVICES MADE

Date	Operating hours	Remarks
1. _____	_____	_____ _____
2. _____	_____	_____ _____
3. _____	_____	_____ _____
4. _____	_____	_____ _____
5. _____	_____	_____ _____
6. _____	_____	_____ _____
7. _____	_____	_____ _____
8. _____	_____	_____ _____
9. _____	_____	_____ _____
10. _____	_____	_____ _____

EC DECLARATION OF CONFORMITY

1. Manufacturer: **Avant Tecno Oy**
Ylötie 1
FI-33470 YLÖJÄRVI
FINLAND

2. **We hereby declare that the machines listed below conform to EC Directives, as they are amended: 2006/42/EC (Machinery), 2004/108/EC (EMC) and 2000/14/EC (Noise Emission).**

3. Category: **EARTH-MOVING MACHINERY/LOADERS/COMPACT**

4. Model: **AVANT** _____

5. Serial Number: _____

6. Year of Manufacture: **2012**

7. Directive / Conformity Assessment Procedure / Notified Body:

2006/42/EC	Self-certification	-----
2004/108/EEC	Self-certification	-----
2000/14/EC	Type-test	MTT Agrifood research Finland, Measurement & Standardization, Vakolantie 55, 03400 Vihti, FINLAND

8. Issuer of declaration and person authorized to compile technical construction file:

9. Name: **Risto Käkelä**

10. Position/Title: **Managing Director**

11. (Signature) _____

12. Place: **Ylöjärvi, Finland**

13. Date: _____



AVANT[®]

Avant Tecno Oy
Ylötie 1
FIN-33470 YLÖJÄRVI, FINLAND
Tel. +358 3 347 8800
Fax +358 3 348 5511
e-mail: sales@avanttecno.com

AVANT has a policy of continuing improvement, and retains the right to change specifications without notice. © 2012 AVANT Tecno Oy. Kaikki oikeudet pidätetään.

www.avanttecno.com